

CALIFORNIA FIRE CODE – MATRIX ADOPTION TABLE
APPENDIX D – FIRE APPARATUS ACCESS ROADS
(As Adopted by San Jose Fire Department)

Adopting Agency	BSC	BSC-CG	SJFD		HCD			DSA		OSHDP				BSCC	DPH	AGR	DWR	CEC	CA	SL	SLC
			T-24	T-19*	1	2	1/AC	AC	SS	1	2	3	4								
Adopt Entire Chapter																					
Adopt Entire Chapter as amended (amended sections shown as SJFD)			X	X																	
Adopt only those sections that are listed below																					
[California Code of Regulations, Title 19, Division 1]																					
Chapter / Section																					

* The California Code of Regulations (CCR), Title 19, Division 1 provisions that are found in the California Fire Code are a reprint from the current CCR, Title 19, Division 1 text for the code user's convenience only. The scope, applicability and appeals procedures of CCR, Title 19, Division I remain the same.

APPENDIX D
FIRE APPARATUS ACCESS ROADS

The provisions contained in this appendix are not mandatory unless specifically referenced in the adopting ordinance.

SECTION D101
GENERAL

D101.1 Scope. Fire apparatus access roads shall be in accordance with this appendix and all other applicable requirements of the California Fire Code.

SECTION D102
REQUIRED ACCESS

D102.1 Access and loading. Facilities, buildings or portions of buildings hereafter constructed shall be accessible to fire department apparatus by way of an approved fire apparatus access road with an asphalt, concrete or other approved driving surface capable of supporting the imposed load of fire apparatus weighing at least 75,000 pounds (34 050 kg).

SECTION D103
MINIMUM SPECIFICATIONS

D103.1 Access road width with a hydrant. Where a fire hydrant is located on a fire apparatus access road, the minimum road width shall be 26 feet (7925 mm), exclusive of shoulders (see Figure D103.1).

D103.2 Grade. Fire apparatus access roads shall not exceed 10 percent in grade.

Exception: Grades steeper than 10 percent as approved by the fire chief.

D103.3 Turning radius. The minimum turning radius shall be 30 feet inside radius.

D103.4 Dead ends. Dead-end fire apparatus access roads in excess of 150 feet (45 720 mm) shall be provided with width and turnaround provisions in accordance with Table D103.4.

TABLE D103.4
REQUIREMENTS FOR DEAD-END
FIRE APPARATUS ACCESS ROADS

LENGTH (feet)	WIDTH (feet)	TURNAROUNDS REQUIRED
0-150	20	None required
151-500	20	140-foot Hammerhead, 70-foot "Y" or 96-foot diameter cul-de-sac in accordance with Figure D103.1
501-750	26	140-foot Hammerhead, 70-foot "Y" or 96-foot diameter cul-de-sac in accordance with Figure D103.1
Over 750		Special approval required

For SI: 1 foot = 304.8 mm.

D103.5 Fire apparatus access road gates. Gates securing the fire apparatus access roads shall comply with all of the following criteria:

- Where a single gate is provided, the gate width shall be not less than 20 feet (6096 mm). Where a fire apparatus road consists of a divided roadway, the gate width shall be not less than 14 feet (3658 mm).
- Gates shall be of the swinging or sliding type.
- Construction of gates shall be of materials that allow manual operation by one person.

**San Jose Fire Department Amended Figure D103.1
Dead-End Fire Apparatus Access Road Turnaround**

**See Insert page 620A for
San Jose Fire Department
Modified Figure D103.1**

4. Gate components shall be maintained in an operative condition at all times and replaced or repaired when defective.
5. Electric gates shall be equipped with a means of opening the gate by fire department personnel for emergency access. Emergency opening devices shall be approved by the fire code official.
6. Methods of locking shall be submitted for approval by the fire code official.
7. Electric gate operators, where provided, shall be listed in accordance with UL 325.
8. Gates intended for automatic operation shall be designed, constructed and installed to comply with the requirements of ASTM F2200.

D103.6 Signs. Where required by the fire code official, fire apparatus access roads shall be marked with permanent NO PARKING—FIRE LANE signs complying with Figure D103.6. Signs shall have a minimum dimension of 12 inches (305 mm) wide by 18 inches (457 mm) high and have red letters on a white reflective background. Signs shall be posted on one or both sides of the fire apparatus road as required by Section D103.6.1 or D103.6.2.

D103.6.1 Roads 20 to 26 feet in width. Fire lane signs as specified in Section D103.6 shall be posted on both sides of fire apparatus access roads that are 20 to 26 feet wide (6096 to 7925 mm).

D103.6.2 Roads more than 26 feet in width. Fire lane signs as specified in Section D103.6 shall be posted on one side of fire apparatus access roads more than 26 feet wide (7925 mm) and less than 32 feet wide (9754 mm).

**SECTION D104
COMMERCIAL AND INDUSTRIAL DEVELOPMENTS**

D104.1 Buildings exceeding three stories or 30 feet in height. Buildings or facilities exceeding 30 feet (9144 mm) or three stories in height shall have at least two means of fire apparatus access for each structure.

D104.2 Buildings exceeding 62,000 square feet in area. Buildings or facilities having a gross building area of more than 62,000 square feet (5760 m²) shall be provided with two separate and approved fire apparatus access roads.

Exception: Projects having a gross building area of up to 124,000 square feet (11 520 m²) that have a single approved fire apparatus access road when all buildings are equipped throughout with approved automatic sprinkler systems.

D104.3 Remoteness. Where two fire apparatus access roads are required, they shall be placed a distance apart equal to not less than one half of the length of the maximum overall diagonal dimension of the lot or area to be served, measured in a straight line between accesses.

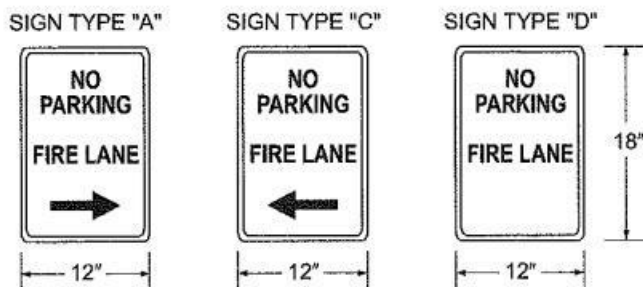

**FIGURE D103.6
FIRE LANE SIGNS**

San Jose Fire Department Amended Figure D103.1 Dead-End Fire Apparatus Access Road Turnaround

Not to Scale

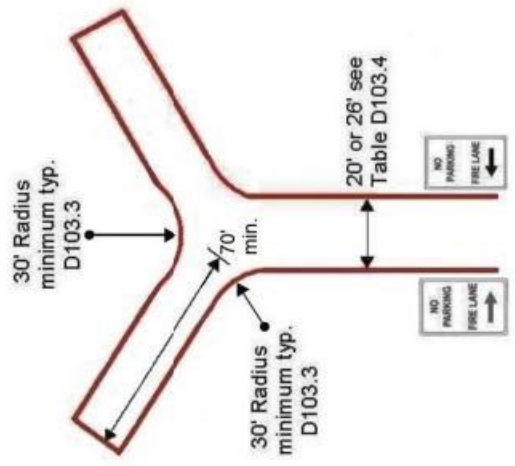
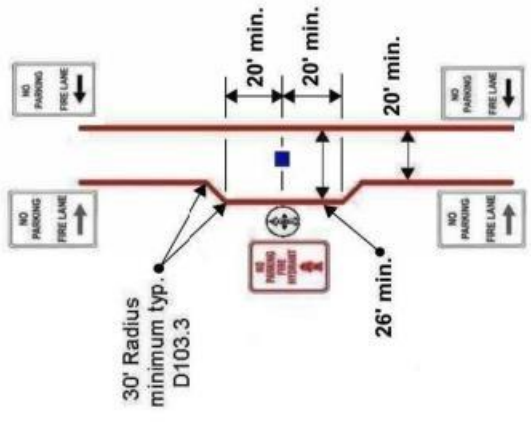

"Y"

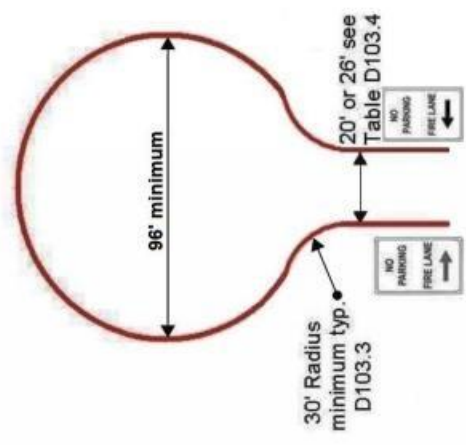

Cul-De-Sac

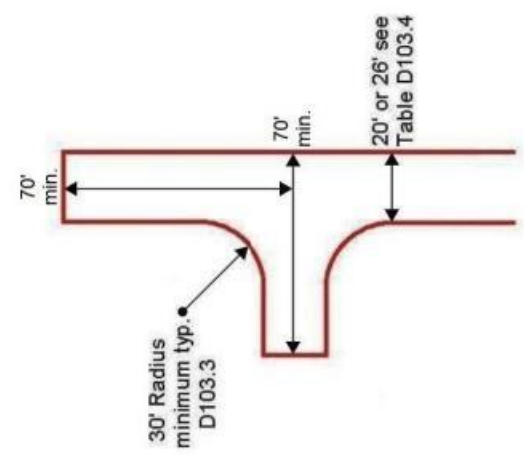

Alternative Hammerhead

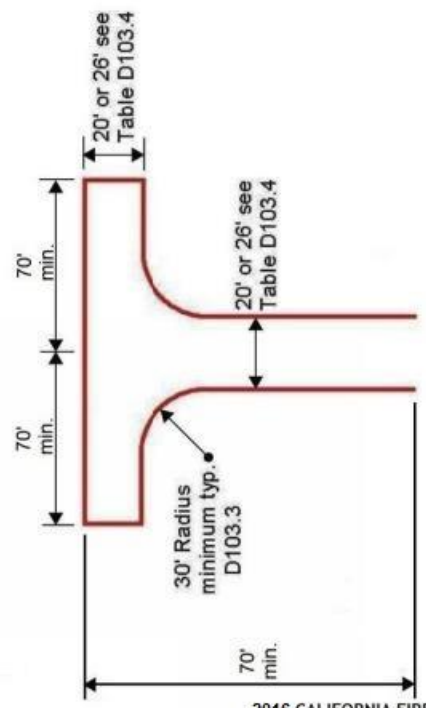

Hammerhead

Access Road Width Examples

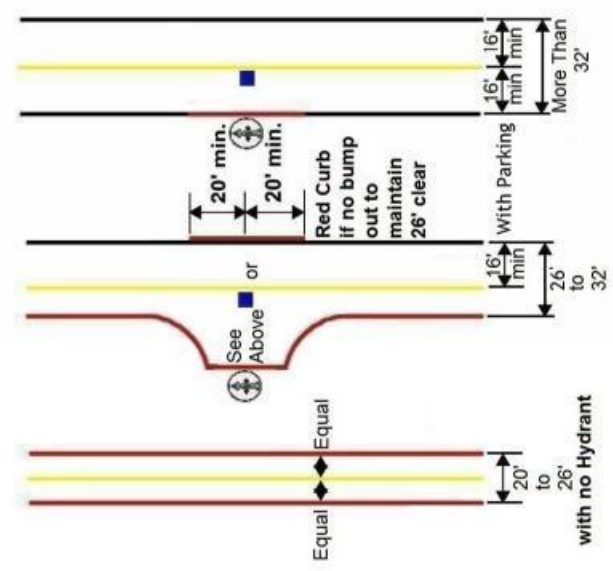

SECTION D105 AERIAL FIRE APPARATUS ACCESS ROADS

D105.1 Where required. Where the vertical distance between the grade plane and the highest roof surface exceeds 30 feet (9144 mm), approved aerial fire apparatus access roads shall be provided. For purposes of this section, the highest roof surface shall be determined by measurement to the eave of a pitched roof, the intersection of the roof to the exterior wall, or the top of parapet walls, whichever is greater.

SJFD

Exception: High-rise structures shall not require aerial fire apparatus access roads.

D105.2 Width. Aerial fire apparatus access roads shall have a minimum unobstructed width of 26 feet (7925 mm), exclusive of shoulders, in the immediate vicinity of the building or portion thereof.

D105.3 Proximity to building. At least one of the required access routes meeting this condition shall be located within a minimum of 15 feet (4572 mm) and a maximum of 30 feet (9144 mm) from the building, and shall be positioned parallel to one entire side of the building. The side of the building on which the aerial fire apparatus access road is positioned shall be approved by the fire code official.

D105.4 Obstructions. Overhead utility and power lines shall not be located over the aerial fire apparatus access road or between the aerial fire apparatus road and the building. Other obstructions shall be permitted to be placed with the approval of the fire code official.

SECTION D106 MULTIPLE-FAMILY RESIDENTIAL DEVELOPMENTS

D106.1 Projects having more than 100 dwelling units. Multiple-family residential projects having more than 100 dwelling units shall be equipped throughout with two separate and approved fire apparatus access roads.

Exception: Projects having up to 200 dwelling units may have a single approved fire apparatus access road when all buildings, including nonresidential occupancies, are equipped throughout with approved automatic sprinkler systems installed in accordance with Section 903.3.1.1 or 903.3.1.2.

D106.2 Projects having more than 200 dwelling units. Multiple-family residential projects having more than 200 dwelling units shall be provided with two separate and approved fire apparatus access roads regardless of whether they are equipped with an approved automatic sprinkler system.

D106.3 Remoteness. Where two fire apparatus access roads are required, they shall be placed a distance apart equal to not less than one-half of the length of the maximum overall diagonal dimension of the property or area to be served, measured in a straight line between accesses.

SECTION D107 ONE- OR TWO-FAMILY RESIDENTIAL DEVELOPMENTS

D107.1 One- or two-family dwelling residential developments. Developments of one- or two-family dwellings where the number of dwelling units exceeds 30 shall be provided with two separate and approved fire apparatus access roads.

Exceptions:

1. Where there are more than 30 dwelling units on a single public or private fire apparatus access road and all dwelling units are equipped throughout with an approved automatic sprinkler system in accordance with Section 903.3.1.1, 903.3.1.2 or 903.3.1.3 of the *California Fire Code*, access from two directions shall not be required.
2. The number of dwelling units on a single fire apparatus access road shall not be increased unless fire apparatus access roads will connect with future development, as determined by the fire code official.

D107.2 Remoteness. Where two fire apparatus access roads are required, they shall be placed a distance apart equal to not less than one-half of the length of the maximum overall diagonal dimension of the property or area to be served, measured in a straight line between accesses.

SECTION D108 REFERENCED STANDARDS

ASTM	F2200—13	Standard Specification for Automated Vehicular Gate Construction	D103.5
ICC	IFC—15	International Fire Code	D101.1, D107.1
UL	325—02	Door, Drapery, Gate, Louver, and Window Operators and Systems, with Revisions through June 2013	D103.5